



3E MAKİNA
SAN. VE TİC. LTD. ŞTİ.

VENTILATION DUCT MACHINES
[Made by 3E]



3E MAKİNA SAN. VE TİC. LTD. ŞTİ.

Sac Kesim ve Büküm Teknolojisi • Sheet Cutting and Bending Technology
HAVALANDIRMA KANAL MAKİNALARI • VENTILATION DUCT MACHINES



PRİZMATİK KANAL MAKİNALARI
PRISMATIC DUCT MACHINES



PLAZMA MAKİNALARI
PLASMA CUTTING MACHINES

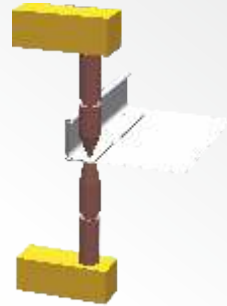

PUNTA KAYNAK MAKİNALARI
SPOT WELDING MACHINES



ÖZEL MAKİNALAR
SPECIAL MACHINES

*Üretmiş Olduğumuz Havalandırma Kanal Makinaları
Türkiye ve Avrupa Ülkelerinde Hızla Yayılmaktadır*
*Ventilation Duct Machines of Our Manufacture Are
Rapidly Spread In Turkey And European Countries*





Hakkımızda

Firmamız 2011 yılında İstanbul'da kurulmuştur. Ana faaliyet alanımız havalandırma sektörünün ihtiyacı olan metal sac işleme ve form verme makinalarının tasarımı ve üretimidir. Firmamız, özellikle Kare Kanal Makinası, Pançlı Kare Kanal Makinası, Rulo Açıcı, Kanal Kapatma Makinası, Plazma Kesim Makinası, Kenet Makinası, Flaş Kesme Makinası, Santim Makinası, Kare Dirsek Kapatma Makinası gibi makina tasarımı ve imalatında uzmanlaşmıştır. Müşterilerimizin taleplere cevap vererek halen 1500 m2'lik kapalı alanda imalatımızı sürdürmekte ve ürettiğimiz ürünleri yurtiçi ve yurtdışına pazarlamaktayız. '3E Makina' olarak kuruluşumuzun ana prensibi: 'Mükemmelliğin sonu yoktur'. Bu bitmeyen yolda her zaman yenilikçi fikirler ve sürekli Ar-Ge çalışmaları ile imalatımızı geliştirmekteyiz. Büyük önem verdiğimiz üretimimizin yüksek kalitesi, uygun fiyat politikamız ve satış sonrası teknik destek hizmeti sayesinde '3E Makina' kısa sürede havalandırma sektöründe hem yurt içi hem yurt dışı piyasada en çok tercih edilen marka haline gelmiştir. '3E Makina' tarafından imal edilen havalandırma kanal, profil, form verme ve merdaneli biçimleme makinaları Türkiye'nin her ilinde mevcut olup Asya ve Avrupa ülkelerine hızla yayılmaktadır.

Misyonumuz

Havalandırma sektörünün ihtiyacı olan metal sac işleme ve form verme makinalarının tasarımı ve üretimini en iyi şekilde yapmak ve uluslararası standartları Türkiye'ye getirerek ülkenin milli üretimini arttırmaktır.

Vizyonumuz

Havalandırma kanal makinası ve diğer metal sac işleme ve form verme makinaları alanında gelişmek ve kurumumuzun öncü rolünü sürdürmektir. İmal ettiğimiz ürünlerde ve sunduğumuz hizmetlerde daima kaliteyi kılavuz edinen ve ondan taviz vermeden sektörün sağlayabildiği en kısa sürede makina imalatını bitiren, havalandırma sektöründe en hızlı büyüyen ve uluslararası rekabette güçlü bir firma oluşturmaktır.

About US

Our company was established in 2011 in Istanbul. The main area of our activity is the design and production of the metal sheet processing and forming machines which are required by the ventilation industry. Our company is specialized in design and manufacturing of the machines especially like Auto Duct Forming Machine, ADF Line With Notching System, Uncoiler, Seam Closing Machine, Plasma Cutting Machine, Lock Forming Machine, Flange Cutting Machine, Flanging Machine, Pittsburgh Seam Closer Machine. By responding to the demands of our customers we are carrying on our manufacture at our 1500 m2 closed area and marketing products we manufactured to domestic and overseas markets. The main principle of our establishment as of '3E Makina' is: 'There Is No End Of The Perfectness'. On this never-ending way we are always improving our manufacture with innovative ideas and continuous R&D activities. Thanks to the high quality of our production to which we pay a lot of attention, our fair price policy and after-sale technical support services '3E Makina' in a short period of time became the most preferred brand in the ventilation industry on both domestic and abroad markets. Ventilation duct, profile, forming and roll-forming machines produced by '3E Makina' being available in each province of Turkey are rapidly spread across Asian and European countries.

Our Mission

To fulfill the design and production of the metal sheet processing and forming and machines required by the ventilation industry in the best way and to increase national manufacture by bringing international standards to Turkey.

Our Vision

To develop ourselves in the area of ventilation duct machinery and other metal sheet processing and forming equipment and to maintain pioneering role of our enterprise. To create the fastest growing and internationally competitive strong company that always is guided by the quality of the products we manufacture and of the services we provide and the company that finishes the manufacture of the machine in the shortest period that is possible in this sector without compromising on the quality.

KKM-01 KARE KANAL MAKİNASI (HİDROLİK SİSTEM)



Makina, dikdörtgen kanalın yanında ayrıca programlamaya ihtiyaç olmadan U şeklinde, L şeklinde ve düz sac çıkartabilmektedir. Ayrıca Pittsburgh, Snaplock, Numlock kenet tiplerini yapabilmektedir. Kare Kanal Makinası Servo motor ve Servo redüktör sistemi ile ölçülerde kesinlikle hata yapmaz.



Makinanın Özellikleri

- Tam otomatik olarak çalışma (PLC kontrollü)
- 2 adet besleme ünitesi
- 2 adet saca desen verme ünitesi (saca iz, form verme)
- 1 adet düzleştirici
- Servo motorlu ve Servo redüktörlü
- Hidrolik sistem
- Etiket çıkartma özellikli
- Üretim kapasitesi 180 m²/saat

İZ DESENLERİ

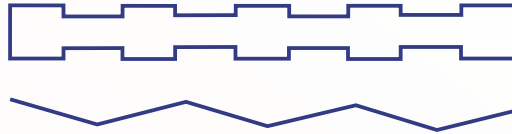

Teknik Özellikleri

- Sac Kesim-Büküm Kapasitesi :Min:0.5mm - Max:2.0mm
- Bükülebilen Kanal Boyu (min) :150x150
- Boyutları :En 2.000mm x Boy 2.000mm x Yükseklik 1.500mm
- Ağırlığı :2.500Kg
- Motor gücü :2.2Kw Servo Motor



— Düz Sac

└ L Sac

└ U Sac

□ Kare Kanal

□ S Kenedi

KKM-01 AUTO DUCT LINE (HYDRAULIC SYSTEM)



The machine along with rectangular duct is able to produce U and L shaped and flat metal sheets without need in programming. It can also produce Pittsburgh, Snaplock, Nulock lock types. Auto Duct Former with its Servo engine and Servo reducer systems definitely does not make the mistake in measurements.



Machine Features

- Fully automatic operation (PLC controlled)
- 2 pieces of feeding unit
- 2 pieces of sheet patterning unit (sheet profile making, forming)
- 1 piece of straightener
- With Servo engine and Servo reductor
- Hydraulic system
- Label stickers featured
- Production capacity is 180m²/hour

PROFILE PATTERNS

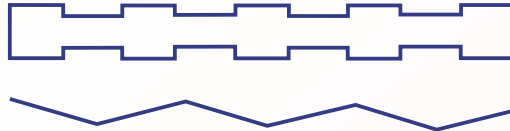

Technical Specifications

- Sheet cutting bending capacity :Min:0.5mm - Max:2.0mm
- Bendable duct length (min) :150x150
- Dimensions :Width 2.000mm x Length 2.000mm x Height 1.500mm
- Weight :2.500Kg
- Engine Power :2.2Kw Servo Engine



- Flat Sheet
- L-Shaped Sheet
- U-Shaped Sheet
- Square Duct
- S-Shaped Shutter

PKM-01 PANÇLI KARE KANAL MAKİNASI



Makina, Kare Kanal Makinası ile aynı özelliklere sahiptir. Kendinden flanşlı kanal üretebilmek için gerekli boşaltmaları yapmaktadır. Makinamız, hem çakma flanş hem de kendinden flanşlı kanalı imal edilebilecek şekilde yapılmıştır. Pança ek olarak, hidrolik sistem, 4 adet kalıp (ikisi sağda, ikisi solda) olmak üzere tasarlanmıştır.



Makinanın Özellikleri

- Tam otomatik olarak çalışma (PLC kontrollü)
- 2 adet besleme ünitesi
- 2 adet saca desen verme ünitesi (saca iz, form verme)
- 1 adet düzleştirici
- Servo motorlu ve Servo redüktörlü
- Hidrolik sistem
- Etiket çıkartma özelliği
- Üretim kapasitesi 180 m2/saat



Teknik Özellikleri

- Sac Kesim-Büküm Kapasitesi :Min:0.5mm - Max:2.0mm
- Bükülebilir Kanal Boyu (min) :150x150
- Boyutları :En 2.000mm x Boy 2.000mm x Yükseklik 1.500mm
- Ağırlığı :3.000Kg
- Motor gücü :2.2Kw Servo Motor

Kendinden Flanşlı

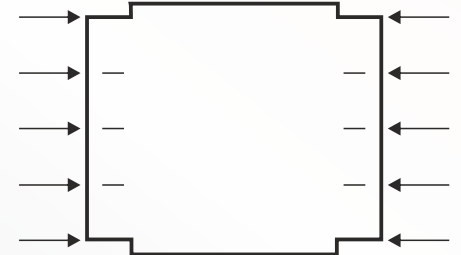

— Düz Sac

┌ L Sac

└ U Sac

□ Kare Kanal

□ S Kenedi

PKM-01 AUTO DUCT FORMER WITH NOTCHING SYSTEM



The machine has the same features as the Auto Duct Former. It makes necessary discharges in order to be able to produce self-flanged duct. Our machine is made so that it can produce both nailed flanged and self-flanged ducts. Additionally to notching system it is designed with hydraulic system and 4 pieces of punching die (two of them at the right and two at the left).



Machine Features

- Fully automatic operation (PLC controlled)
- 2 pieces of feeding unit
- 2 pieces of sheet patterning unit (sheet profile making, forming)
- 1 piece of straightener
- With Servo engine and Servo reductor
- Hydraulic system
- Label stickers featured
- Production capacity is 180m²/hour



Technical Specifications

- Sheet cutting bending capacity :Min:0.5mm - Max:2.0mm
- Bendable duct length (min) :150x150
- Dimensions :Width 2.000mm x Length 2.000mm x Height 1.500mm
- Weight :3.000Kg
- Engine Power :2.2Kw Servo Engine

Self-Flanged

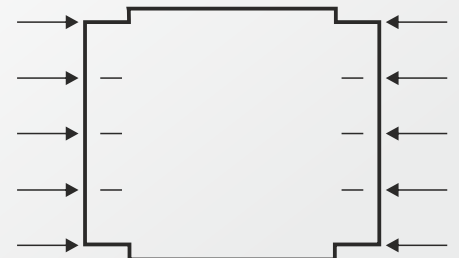

KKM-02 KANAL KAPATMA MAKİNASI



Havalandırma sistemlerinde en çok kullanılan Numlock kenet ile birleştirilmesi için tasarlanmış bir makinedir. Kare Kanal Makinesinden çıkan kare ve dikdörtgen kanalları kapatmak için kullanılır. Sessiz ve hızlı üretim elde edilir.



Teknik Özellikleri

- Güç :3Kw
- Gerilim-Frekans :380-400 VAC/50-60Hz/3 Faz
- Akım :7.2A
- Çalışma hızı :9m/dk
- Sac kalınlıkları :0.5mm-1.20mm Galvaniz sac
:0.5mm-0.70mm Paslanmaz sac
- Boyutları :En:800 Boy:4700 Yükseklik:1000mm
- Net Ağırlık :640Kg

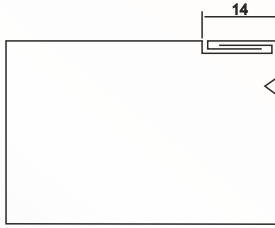

Kanal Kapatma

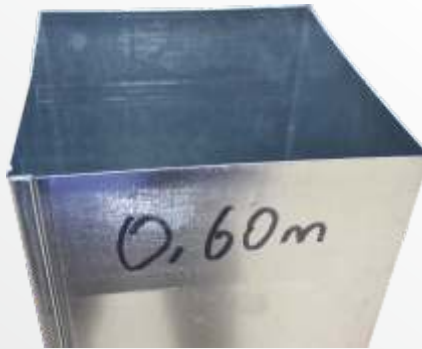

KKM-02 SEAM CLOSER



A machine that is designed for combining with Numlock lock which is the most used in ventilation systems. It is used to close seams of square and rectangle ducts done by Auto Duct Former. Silent and fast production is achieved.

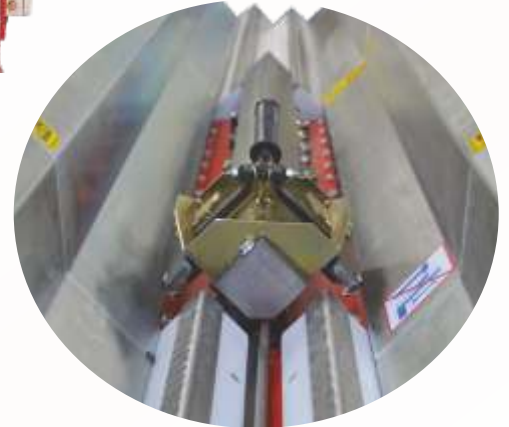

Technical Specifications

- Power :3Kw
- Voltage-Frequency :380-400 VAC/50-60Hz/3 Faz
- Current :7.2A
- Operating speed :9m/dk
- Sheet thickness :0.5mm-1.20mm Galvanized sheet
:0.5mm-0.70mm Stainless sheet
- Dimensions :Width:800 Length:4700 Height:1000mm
- Net Weight :640Kg

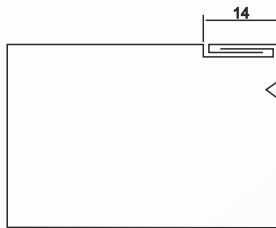

Seam Closing

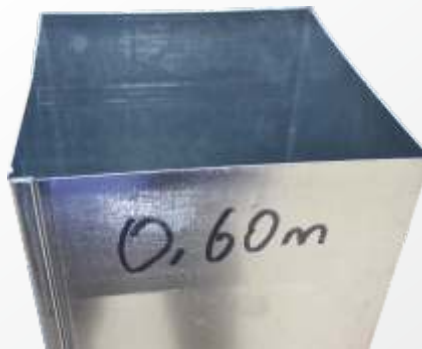
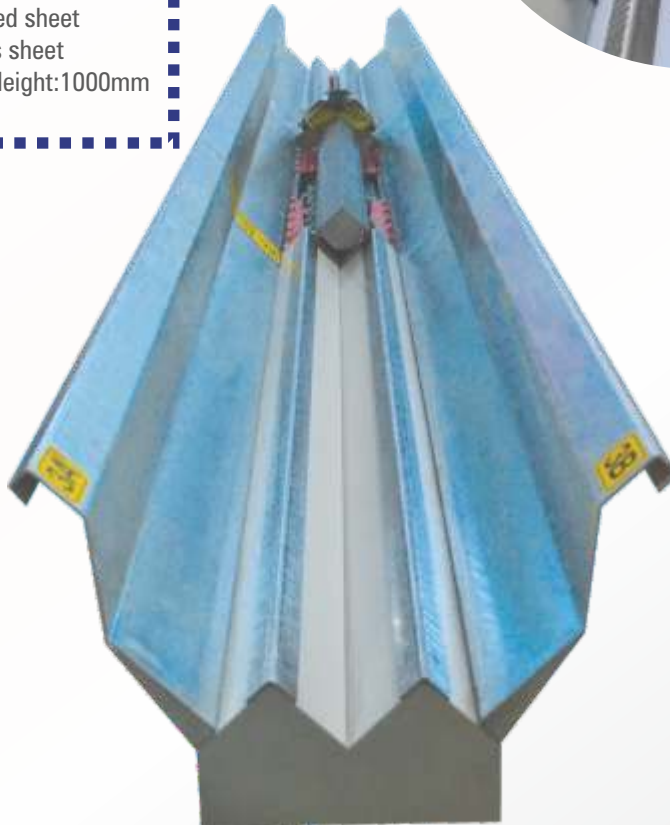

PLZ-01 PLAZMA KESİM MAKİNASI



6 mm'ye kadar hızlı, hassas ve kaliteli kesim yapabilen özellikle havalandırma kanal imalatçıları, reklamcılar ve ince sac kullanan müşterilerimiz için geliştirilmiş bir makinedir. Ekonomik fiyatının yanında ergonomik özelliklerle donatılmış bu CNC Plazma Kesim Makinesi bu sektörlerdeki birçok müşterimizin vazgeçilmez yardımcıları olmuştur. Köprüdeki çift Stepper motor sistemi, hassas Lineer raylar üzerindeki hareketli aksamlar makinenin rakiplerine göre büyük avantajlar sunmaktadır. Ayrıca Autodesk Fabrication CAMduct ve Lantek Havalandırma programları ile %100 uyumludur.

TEZGAH KESİM ÖLÇÜSÜ : 1500X 3000 MM

Makinanın Özellikleri

Windows tabanlı CNC kontrol ünitesi
Hypertherm plazma güç ünitesi
Tüm eksenler Leadshine Stepper
Pnömatik Z eksen
20 mt/dk eksen hızı
Hiwin Lineer Ray



Teknik Özellikleri

■ Güç	: 11Kw
■ Gerilim-Frekans	: 380-400 VAC/50-60Hz/3 ph+PE
■ Akım	: 30A
■ Hava İhtiyacı	: 189 L/dk
■ Hava Basıncı	: 7 bar
■ Net Çalışma Alanı	: 1500mm x 3000mm
■ Max. Çalışma Hızı	: 20 m/dk (Boştaki Hızı)
■ Kesme hızı	: 7-9/dk
■ Tabla Taşıma Kapasitesi	: 1400 Nm2
■ Sac Kalınlıkları Opsiyonlu	: 0.5-5 mm arası Galvaniz, Alüminyum Siyah DKP/HRP 0.5 mm paslanmaz
■ En	: 2400 mm
■ Boy	: 4500 mm
■ Yükseklik	: 1400 mm
■ Ağırlık	: 1000 kg



PLZ-01 PLASMA CUTTER



A machine which is able to perform fast, precise and high quality cutting up to 6 mm is developed especially for ventilation duct manufacturers, advertisers and customers who use thin metal sheet. Along with the economic price this CNC Plasma Cutting Machine equipped with ergonomic features has become irreplaceable assistant for the most customers in this industry. Double Stepper engine system on the bridge, moving parts upon the precise Linear rails provide huge advantages comparing to the competitors of this machine. Also it is %100 compatible with Autodesk Fabrication Camduct and Lantek Ventilation programs.

WORKBENCH CUTTING MEASUREMENTS : 1500X 3000 MM

Machine Features

Windows based CNC control unite
Hypertherm plasma power unit
All axes are Leadshine Stepper
Pneumatic Z axe
20 mt/min exe speed
Hiwin Linear rail



Teknik Özellikleri

Engine Power	: 11Kw
Voltage-Frequency	: 380-400 VAC/50-60Hz/3 ph+PE
Current	: 30A
Air Requirement	: 189 L/dk
Air Pressure	: 7 bar
Working Area	: 1500mm x 3000mm
Max. Working Speed	: 20 m/dk (Boştaki Hızı)
Cutting Speed	: 7-9/dk
Plate Carrying Capacity	: 1400 Nm2
Sheet Thicknesses	: 0.5-5 mm Galvenize, Aliminium
(Optional)	Black DKP/HRP 0.5-3mm Stainless Steel
Length	: 2400 mm
Width	: 4500 mm
Height	: 1400 mm
Weight	: 1000 kg



PSB-01 PLAZMA SAC BESLEME MAKİNASI PSB-01 PLASMA SHEET FEEDING MACHINE



Plazma makinalarında tabaka saclara bağımlı kalmaksızın ihtiyacınız kadar sacı plazma sehpasına sürmeye yarayan makinamız ile fireleri en aza indirebilirsiniz.



You can reduce ullages to the minimum as much as you need with our machine that helps to push metal sheet to the plasma stand without being dependent on the steel plates in the plasma machines.

Teknik Özellikler

En/Width	:800mm
Boy/Length	:1600mm
Yükseklik/Height	:1200mm
Ağırlık/Weigth	:220kg
Kapasite/Capacity	:1.2mm
Elektrik/Electricity	:380V/4 HP/50 Hz
Motor Gücü/Engine Power	:1.1 kW



PSB-02 PLAZMA SAC BESLEME MAKİNASI 3 GİRİŞLİ



Plazma makinalarında tabaka saclara bağımlı kalmaksızın ihtiyacınız kadar sacı plazma sehpasına sürmeye yarayan makinamız ile fireleri en aza indirebilirsiniz. Makinanın 3 girişli olması işçiliği ve üretimi daha seri hale getirir.



Thanks to our machine you can spread sheets as much as you need, notwithstanding to sheet plates in plasma tables. As a result of machine has 3 entrance, production and labour can be more faster and more serialized.

Teknik Özellikler

En/Width	:1220mm
Boy/Length	:2100mm
Yükseklik/Height	:1200mm
Ağırlık/Weigth	:800kg
Kapasite/Capacity	:0.50 - 1.2 mm
Elektrik/Electricity	:380V/4 HP/50.60 Hz
Motor Gücü/Engine Power	:2.2 kW

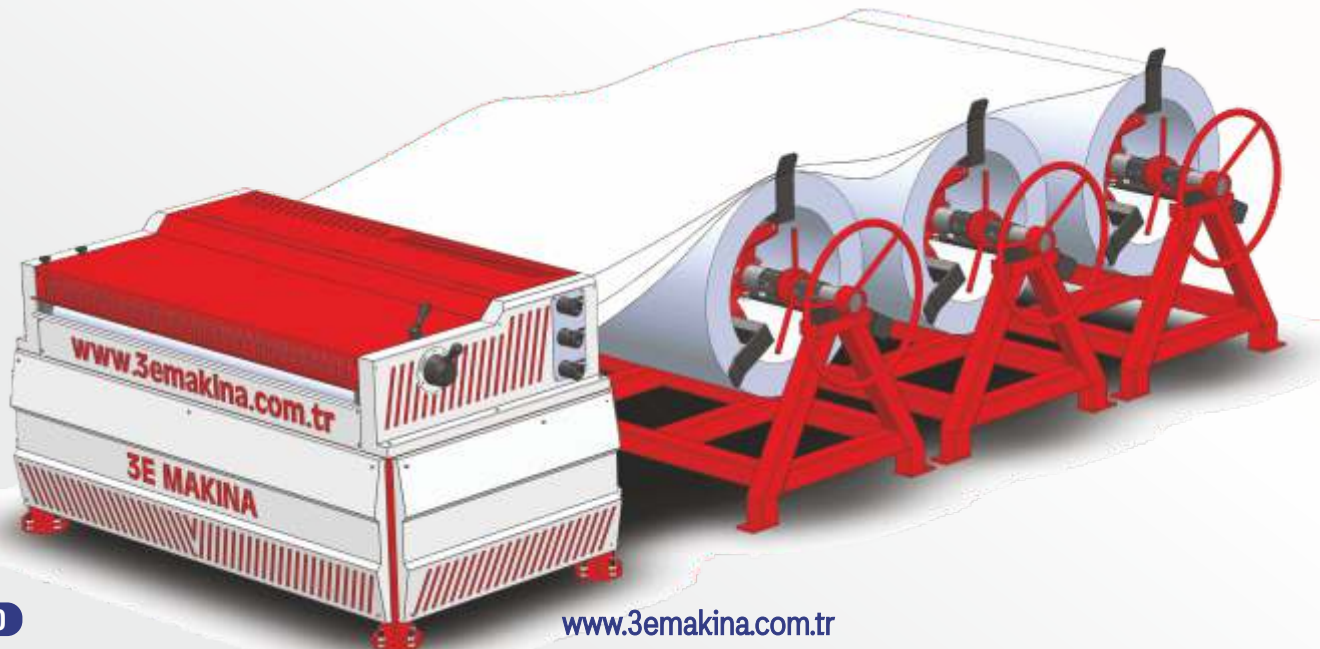

BKEM-01 BORU KENET EZME MAKİNASI

BKEM-01 PIPE LOCK SEAMER



Boru Kenet Ezme Makinası, her türlü kenetlenmiş boruyu, dikişi, içte büküm, dışta büküm veya ortada olacak şekilde mükemmel bir şekilde ezer. Pnömatik basınçla 150 mm çaptan 1000 mm çapa kadar borunun dikiş yerlerini ezabilir. Havalandırma boruları, güneş enerji sistemleri gibi estetik ve sızdırmazlık gerektiren boru dikişlerinde mükemmellik sağlar. Makina, boru dikişlerini ezerken oluşan çekiç gürültüsünü sıfıra indirir. 120cm'lik borunun dikişini 3 saniye gibi kısa bir sürede düzgün ve standart şekilde ezerek işgücünde tasarruf sağlar.



Pipe Lock Seaming Machine perfectly seams any locked pipe, seam, internal, outward or middle twist. It is able to pinch pipe seams of 150mm up to 1000mm diameter with pneumatic pressure. It provides excellence in the seams of pipes like ventilation pipes, solar energy systems that require esthetics and impermeability. The machine reduces to zero the hammer noise resulting during seaming of pipe. It saves labor at the workplace by seaming of a 120cm pipe in a proper and standard manner in such a short time period as 3 seconds.



MAKİNANIN ÖZELLİKLERİ:

- Redüktör tahrikli ezme sistemi
- Pnömatik basan piston sayesinde kolay kullanım
- Standart ayak pedalı ile hem ezme ve hem dönüş kontrol edilir
- Hava şartlandırıcı sistemi ile pnömatik sistem koruma altına alınır
- Sertleştirilmiş ezme topları
- Rulmanlı kızak sistemi
- AB güvenlik direktiflerine uygunluk (CE)
- Kullanım kılavuzu



MACHINE SPECIFICATIONS:

- Reducer driven pinching system
- Easy operation by pneumatic pressing piston
- Pinching and rotation is controlled by a standart foot pedal
- Pneumatic system is protected by the help of air filter
- Hardened seaming rolls
- Slidig system with ball bearing
- Built according to EC Safety Directives and has
- CE Mark
- User's manual

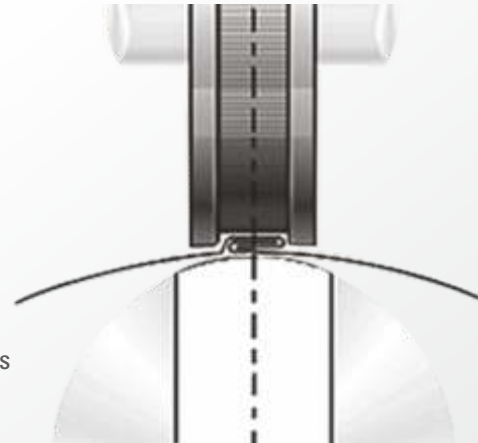

Teknik Özellikler

Technical Specifications

Ezme Boyu/Seam Working Length	:1300mm
Mak. ve Min. Ezme Çapı/Max. & Min. Seaming Diameters	:1000/120mm
Çalışma Basıncı (Pnömatik)/Working Pressure (Pneumatic)	:8bar
Basma Kuvveti/Press Power	:1000kg
Motor Gücü/Motor Power	:0.37kW
Makina Ölçüleri UxGxY/Machine Dimensions LxWxH	:1720x10500x1800
Ağırlık/Weight	:300kg

FKM-01 FLANŞ KESME MAKİNASI FKM-01 FLANCE CUTTING MACHINE



Boy olarak aldığınız flanşların istediğiniz ölçüde ve elmas uçlu testere sayesinde çapaksız olarak kesim yapmak için tasarlanmıştır. Makine pnömatik sistemdir, hava ile çalışmaktadır. Ayak pedalı sayesinde rahatlıkla flanş kesmesini sağlar.



It is designed to make burr-free cutting of the flanges you take in length of whatever measurements you want due to its diamond-tipped saw. The machine has pneumatic system and operates with air. Thanks to its foot pedal it will provide comfortable flange cutting.

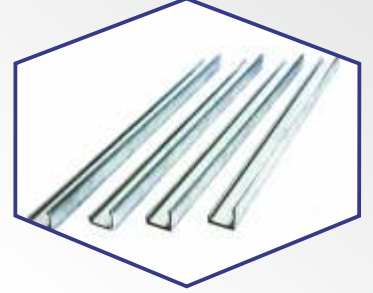

Model	Kapasite Capacity	Elektrik Electric	Motor Gücü Folding Capacity	En Width	Boy Height	Yükseklik Weight	Ağırlık Weight
	mm	V/Hz	kW	mm	mm	mm	kg
FKM-01	1.2 mm	380V/4 HP/50 Hz	1.5 kW	560 mm	720 mm	1000 mm	120 kg

RA-01 RULO AÇICI RA-01 UNCOILER



Rulo Sac Açıcı metal sac sektöründeki firmalar tarafından kullanılmaktadır. Bu ürün 5 ton ağırlığındaki ve sac genişliği 1300 mm'ye kadar olan rulo sacları rahatlıkla açabilme kapasitesine sahiptir. Frenli olması sürücü durduğunda rulonun boşalmasını engeller. Sabit, tekerlekli veya raylı sistem şeklinde olabilir.



Metal Sheet Uncoiler is used by the companies in the metal sheet sector. This product has capacity to easily uncoil sheets with weight of 5 ton and with thickness up to 1300 mm. Brake prevents the coil from being discharged when driver stops. It can be fixed, wheeled or with rail system.



Model	Kapasite Capacity	En Width	Boy Height	Yükseklik Weight	Ağırlık Weight
	ton	mm	mm	mm	kg
RA 01	350 kg- 5 ton	1000 mm	210 mm	1400 mm	160 kg

KDK-01 KARE DİRSEK KAPATMA MAKİNASI KDK-01 PITTSBURGH SEAM CLOSER



☐
Kare dirsek kapatma makinası dirseklerinizin ve düz kanallarınızın pittsburgh kenetlerini sıkı bir şekilde otomatik olarak kapatmanızı sağlar.

☐
Pittsburgh Seam Closing Machine provides automatic tight seam closing of the Pittsburgh locks of your elbow and straight ducts.



Teknik Özellikler Technical Specifications

En/Width	: 760mm
Boy/Length	: 3140mm
Yükseklik/Height	: 1650mm
Çalışma Uzunluğu/Working Length	: 2100mm-1250mm
Max. Sac Kalınlığı/Max Sheet Thickness	: 1,00mm
Çalışma Hızı/Working Speed	: 15mt/dk
Ağırlık/Weight	: 500 kg



KNT-01 KENET MAKİNASI (DİRSEKLİ)



Elektrikli Kenet Makinesi, ısıtma-soğutma ve havalandırma kanallarında kullanılan galvanizli saclara şekil vermeye veya bu kanalların oluşturulmasında gerekli olan bağlantı elemanlarının üretilmesinde kullanılmaktadır. Bu makine, boylamasına olarak 2 çeşit, dairesel olarak da bir çeşit profil üretiminde kullanılmaktadır. Dakikada 6m sac işleyebilir.



Boru Kenedi
Seam Cleat

Kenet
Pittsburg Lock

Dirsek
Round Right Cleat (Elbow)

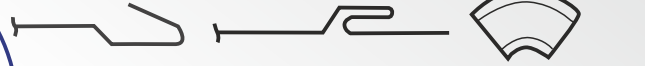

KNT-02 KENET MAKİNASI 9 İSTASYON



Kenet Makinesi, ısıtma-soğutma ve havalandırma kanallarında kullanılan galvanizli saclara şekil vermeye veya bu kanalların oluşturulmasında gerekli olan bağlantı elemanlarının üretilmesinde kullanılmaktadır. Makina da 2 makara seti mevcuttur.

Detaylar ve Opsiyonlar

- 1.5 Mm Saca Form Verme Özelliğine Sahiptir.
- Kenet Ve Boru Kenedi Çıkartmaktadır. Diğer Formlar Opsiyoneldir.
- Tasarlandığı Güçlü Mekanik Sistemi İle Daha Uzun Süre Kullanım Ömrü Sunar.
- Frenli Tekerlek Sayesinde Kolay Kullanım Sağlar.



Model	Elektrik Electric	Motor Gücü Folding Capacity	En Width	Boy Height	Yükseklik Weight	Ağırlık Weight
	V/Hz	kW	mm	mm	mm	kg
KNT-01	380V/4 HP/50 Hz	2 kW	700 mm	1500 mm	1100 mm	250 kg
KNT-02	380V/4 HP/50 Hz	3 kW	700 mm	1500 mm	1100 mm	400 kg

KNT-01 LOCK FORMER (WITH ELBOW)



The Electric Lock Forming Machine is used in the production of fasteners necessary for forming galvanized sheets used in heating-cooling and ventilation ducts or for making these ducts. This machine is used in two types of profile production in a longitudinal direction and one type in a circular one. It can handle 6m sheet metal per minute.



KNT-02 LOCK FORMER 9 STATION



The Lock Former Machine is used to produce galvanized sheets used in heating-cooling and ventilation ducts, or to produce fittings necessary to form these ducts. The machine also has 2 pulley wheel sets.

Details and Options

- Has 1.5 Mm Chamfer Form Specification Feature.
- It Can Produce Clamping And Pipe Clamping. Other Forms Are Optional.
- Thanks To It's Strong Mechanical System It Can Provides A Long Lived Using.
- Easy To Use Thanks To Brake Wheel.

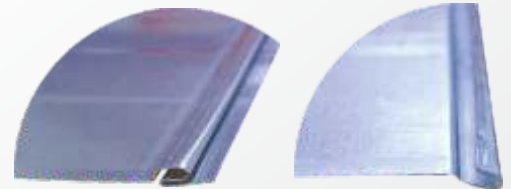

Model	Elektrik Electric	Motor Gücü Folding Capacity	En Width	Boy Height	Yükseklik Weight	Ağırlık Weight
	V/Hz	kW	mm	mm	mm	kg
KNT-01	380V/4 HP/50 Hz	2 kW	700 mm	1500 mm	1100 mm	250 kg
KNT-02	380V/4 HP/50 Hz	3 kW	700 mm	1500 mm	1100 mm	400 kg

CPM-01 C PROFİL MAKİNASI

CPM-01 C PROFILE MAKING MACHINE



Havalandırma kanallarına asmak için gerekli olan profil çeşitlerini üretmektedir. Makina tam otomatik çalışmaktadır. İstenilen ölçü PLC ekrandan girilip istenilen adet kadar kesim yapılmaktadır. Hidrolik kalıplar sayesinde makina profilin içinde bulunmakta olan oval delikleri delmektedir.



It produces profile types necessary for hanging on the ventilation ducts. The machine has full automated operation. The desired size is entered on the PLC screen and the required number of cuts is made. Thanks to hydraulic dies the machine punches oval holes available inside the profile.

Teknik Özellikler

Technical Specifications

En/Width	:2200mm
Boy/Length	:5500+4000mm
Yükseklik/Height	:1600mm
Ağırlık/Weight	:3000kg
Kapasite/Capacity	:0.60-1.20mm
Motor Gücü/Engine Power	:7.5 kW

C,U,L Profil Çeşitleri

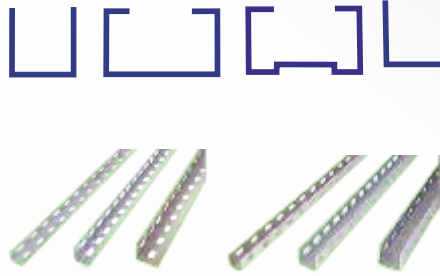

FM-01 TDF KENDİNDEN FLANŞLI MAKİNA FM-01 SELF FLANGED MACHINE



Bu makina TDF flanş yapmak için üretilmiştir. Rol form hattı 14 istasyondan oluşmaktadır. 25-30-35'lik kendinden flanşlı kanal yapabilmektedir.



This machine is produced to make TDF flange. Roll form line consists of 14 station. Machine can make 25-30-35 self flanged air duct.

Teknik Özellikler

En/Width	:1500mm
Boy/Length	:700mm
Yükseklik/Height	:1200mm
Ağırlık/Weight	:1300kg
Kapasite/Capacity	:0.50-1.00mm
Elektrik/Electricity	:380V/4 HP/50 Hz
Motor Gücü/Engine Power	:2 kW

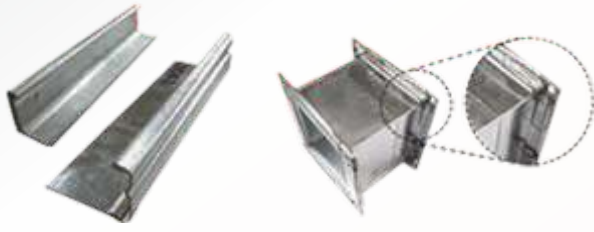

KYM-01 KAREDEN YUVARLAK MAKİNASI KYM-01 RECTANGULAR TO ROUND MACHINE



Bir kenarı yuvarlak diğer kenarı kare olarak kıvrıma işlemi gerçekleştirmek için tasarlanmıştır.



One edge is designed to perform a rounding and other side is designed to perform rectangular bending .

Teknik Özellikler

En/Width	:50mm
Boy/Length	:130mm
Yükseklik/Height	:1000mm
Ağırlık/Weight	:60kg
Kapasite/Capacity	:0.50-1.20mm
Elektrik/Electricity	:380V/4 HP/50 Hz
Hava Basıncı/Air Pressure	:5 bar

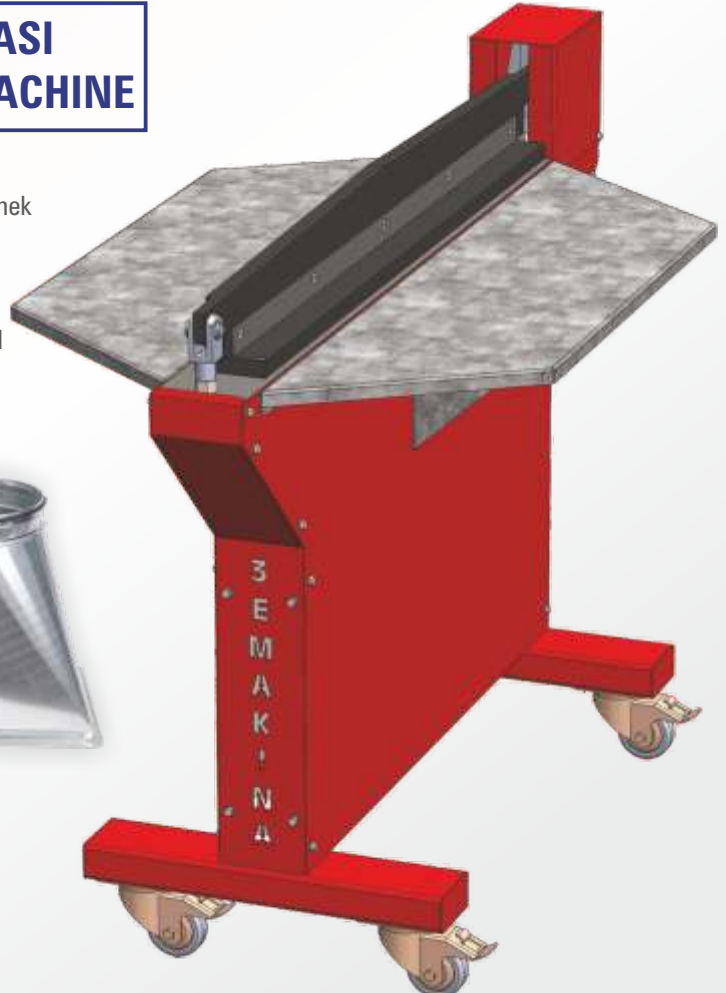

BKM-01 BOY KESME MAKİNASI BKM-01 LENGTH CUTTING MACHINE



1,5mm paslanmaz 3mm galveniz sac kesme kapasiteli servo motor - servo redüktör sistemiyle hatasız kesim yapar.



With capacity to cut 1,5mm stainless and 3mm galvanized sheet servo engine with servo reducer system makes faultless cutting.



MAKİNANIN ÖZELLİKLERİ:

- Plc Ekran Dan İstenilen Ölçü Ve Adet Kesme Kapasitelidir.
- Servo Motor Sistemi Ile Hatasız Kesim Yapmaktadır.
- Yüksek Aşınma Dayanımı Ve Tokluğa Sahip Süreklilik Ve Basınç Dayanımı Yüksek 2379 Soğuk İş Takım Çelik Bıçakları Ile Çapaksız Kesim Yapar.
- 1.5 Mm Paslanmaz 3 Mm Galbaniz Sac Kesme Kapasitesine Sahiptir.



MACHINE SPECIFICATIONS:

- Thanks To PLC Screen,Machine Can Cut Any Quantity And Dimension That User Needs.
- With Servo Engine It Doesn't Make Any Mistake During Cutting Process.
- High Wear Resistance And Durability Continuity And Pressure Resistance High 2379 Cold Work Tool Steel Blades Cuts Burr-Free
- It Has Capacity Of Cutting 1,5mm Stainless And 3mm Galvanized Sheet



Teknik Özellikler Technical Specifications

- Yükseklik/Height :1700mm
- En/Width :1900mm
- Boy/Length :4800mm
- Kapasite/Capacity :0.50 - 4.00mm
- Güç/Power :380V/4HP/50Hz
- Motor/Engine :2kW Servo Motor/Engine
- Ağırlık/Weight :1800kg

İZ-01 İZ MAKİNASI 130 İZ-01 Z PROFILE MACHINE 130



Havalandırma sektöründe ince saclara mukavemet kazandırmak amacıyla kullanılır. Dolu hadde şeklinde imal edilen silindirler 2 mm alüminyum, 1 mm paslanmaz saca form verebilmektedir. İz aralıkları istenilen ölçüde yapılmaktadır. Ezme topları hadde çeliğinden imal olup uzun yıllar dayanır. Ezme millerinde eğrilme olmaması için mukavimdir.



It is used to provide strength to thin sheets in ventilation sector. Cylinders manufactured in full rolling mill form are able to form 2 mm aluminum and 1 mm stainless steel sheets. Pattern intervals are made of desired dimensions. Seaming balls are manufactured from rolled steel and serve for many years. It is resistant to curvature in the seaming mills.



Model	Çalışma Uzunluğu Working Length	Zigzag Kapasitesi Folding Capacity	Motor Gücü Folding Capacity	Uzunluk Length	Genişlik Width	Yükseklik Height	Ağırlık Weight
	mm	mm	kW	mm	mm	mm	kg
İZ 01	1300	0.40-1.20	0.37	1450	480	1050	210
İZ 02	2100	0.40-1.20	1.5	2240	530	1050	360
İZ 03	2600	0.40-1.20	1.5	2740	530	1050	410

İZ-04 İZ MAKİNASI 130 İZ-04 Z PROFILE MACHINE 130



TRAPEZ DESEN

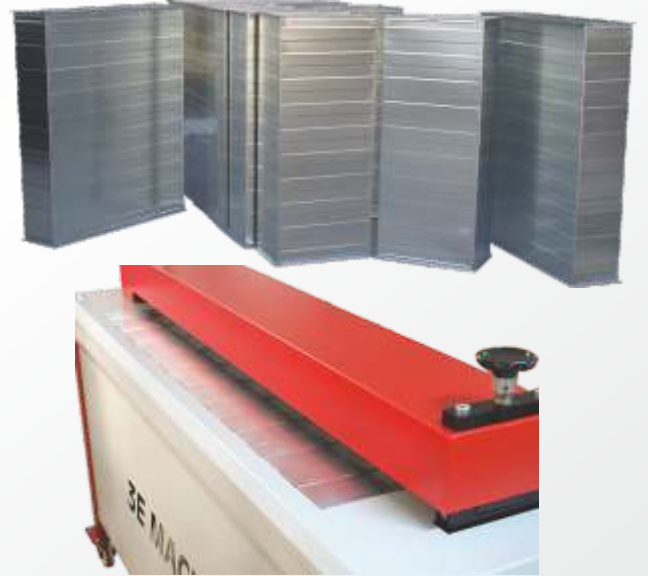

Model	Çalışma Uzunluğu Working Length	Zigzag Kapasitesi Folding Capacity	Motor Gücü Folding Capacity	Uzunluk Length	Genişlik Width	Yükseklik Height	Ağırlık Weight
	mm	mm	kW	mm	mm	mm	kg
İZ 04	1300	0.40-1.20	0.37	1450	480	1050	260

CKM-01-2-3 CAKA MAKİNASI - CKM-01-2-3 HAND OPERATED FOLDING MACHINE



Uzunlukları 1300 mm, 2000 mm, 2500 mm ve 3000 mm olan, 1.2 mm ve altında saclar için kullanılan cakalarımızın tamamı sac gövdeye sahiptir. Bu makinanın tercih sebebi hafif olmasıdır. Şantiyelere kolaylıkla taşınabilir. Tüm bıçakları çelik lamadan üretilmiş olup keskin köşeleri mukavemetlidir. Kol yatakları rulmanlı sistemdir. Personeli yormadan daha rahat çalışma sağlar.



All of our folding machines with lengths of 1300 mm, 2000 mm, 2500 mm and 3000 mm which are used for sheets with lengths, 1.2 mm and under have steel body. The reason of its preference is its light weight. It can be easily carried to the building sites. All of blades being made of flat steel have resistant sharp corners. Connection rod bearings are roller ball bearing system. Provides more comfortable working without tiring out the staff.



Model	Çalışma Uzunluğu Working Length	Bükme Kapasitesi Folding Capacity	Mak. Bükme Açısı Max. Folding Angle	Uzunluk Length	Genişlik Width	Yükseklik Height	Ağırlık Weight
	mm	mm	°	mm	mm	mm	kg
CKM 01	2000	1.2	135	3300	900	1350	490
CKM 02	2500	1.2	135	3700	900	1350	600
CKM 03	3000	1.2	135	4200	900	1350	700

PCM-01 PARÇALI CAKA MAKİNASI 2 METRE PCM-01 PORTATIVE FOLDING MACHINES 2 METERS



Teknik Özellikleri: (PCM-01 2 Metre) Technical Specifications

Çalışma Uzunluğu/Working Length	:2020mm
Bükme Kapasitesi/Folding Capacity	:1.2mm
Mak. Bükme Açısı/Max. Folding Angle	:135
Uzunluk/Length	:3350mm
Genişlik/Width	:900mm
Yükseklik/Height	:1260mm
Ağırlık/Weight	:520kg



SNT-01 SANTİM MAKİNASI SNT-01 FLANGİNG MACHINE



Bu makina, Pittsburgh ve Snaplock birleştirmelerinde erkek tarafı hazırlamak için tasarlanmıştır. Şekil verme geometriye bağlı değildir. Parçaların kenarlarını Pittsburgh veya Snaplock erkek olarak hazırlayabilirsiniz.



This machine is designed for preparing the male side in the combinations of Pittsburg and Snaplock. It doesn't depend on the forming geometry. You can prepare the edges of the parts as Pittsburg or Snaplock male.



Teknik Özellikleri

En/Width	:660mm
Boy/Length	:570mm
Yükseklik/Height	:1300mm
Ağırlık/Weight	:300kg
Elektrik/Electricity	:220VAC/50-60 Hz/3Faz
Motor Gücü/Engine Power	:1 kW



PNT-01 PUNTA KAYNAK MAKİNASI 15kW PNT-01 SPOT WELDING MACHINE 15kW



MAKİNANIN ÖZELLİKLERİ:

- Profilden yapılmış sağlam metal gövde
- Yüksek transformatör gücü
- 5 kademeli akım ayar şalteri
- 1-220V ve 2-380V şebeke gerilimi ile çalışma imkanı
- DKP, paslanmaz ve galvaniz sac ile yüksek performanslı punta yapabilme
- İsteğe bağlı olarak kızaklı alt punta kolu sayesinde daha esnek çalışma imkanı sağlanabilir.
- Alt kol 10cm hareket edebilir. Kızaklı sistem fiyat farkını öğrenmek için iletişim geçiniz.



MACHINE FEATURES

- Strong metal body made from the profile
- High transformer power
- 5 step current adjustment switch
- Opportunity to work with 1-220V and 2-380V network voltage
- Opportunity to make high performance spot with DKP sheet, metal stainless and galvanized sheets
- Depending on demand, more flexible operation can be provided due to the sliding lower spot
- The lower handle can move for 10cm. Please contact us to learn the price difference of the sliding system.



Teknik Özellikleri

Technical Specifications

En/Width	:320mm
Boy/Length	:670mm
Yükseklik/Height	:1300mm
Ağırlık/Weight	:220kg
Elektrik/Electric	:220vac/50-60Hz/3faz

PNT-02 FLANŞ PUNTASI 45kW (YATAY) PNT-02 SPOT WELDING MACHINE 45kW



MAKİNANIN ÖZELLİKLERİ:

- Havalandırma kanallarına flanş puntalanması için tasarlanmıştır.
- Sağlam metal gövde
- Yüksek transformatör gücü
- Punta izlerini en makul seviyeye indirmeye imkan sağlayan; kaynak akımı, sıkma süresi, kaynak süresi, soğuma süresi ve tekrar süresi fonksiyonlarını hassas ayarlayabilen dijital göstergeli elektronik kontrol ünitesi
- DKP, paslanmaz ve galvaniz sac ile yüksek performanslı punta yapabilme
- Bakırdan üretilen punta kolları ve punta uçları ile kesintisiz kaynak kabiliyeti
- Kızaklı punta kolları sayesinde esnek çalışma imkanı (Kollar 5cm hareket edebilir)
- 45kW trafo • 380Vac 2Faz • 24vdc Valf • Pnömatik çalışır • Mikro işlemcili kumanda paneli
- Su soğutmalı • 2mm+2mm Galvaniz sac • 3mm+3mm DKP sac • 3mm+3mm Paslanmaz sac
- Kolay değiştirilebilir elektrot sistemi



MACHINE FEATURES

- Strong metal body
- High transformer power
- Electronic control unit with digital display that provides opportunity to reduce spot tracks to the most reasonable level and can accurately set welding current, squeeze time, welding time, cooling time and repeat time functions
- The possibility to make high performance spot with DKP, stainless and galvanized sheet
- Capability to make endless welding with spot handles and tailstocks made from copper
- Flexible working possibility thanks to sliding spot handles (handles can move for 5cm)
- 45kW transformer 380VAC 2phases 24vdc valve pneumatic operation with microprocessor control panel
- Water cooled 2mm + 2mm galvanized sheet 3mm + 3mm DKP sheet
3mm + 3mm stainless sheet
- Easily replaceable electrode system



Teknik Özellikleri

Technical Specifications

En/Width	:500mm
Boy/Length	:500mm
Yükseklik/Height	:1600mm
Ağırlık/Weight	: 300kg
Elektrik/Electric	: 220vac/50-60Hz/3faz



PNT-03 FLANŞ PUNTASI 45kW (DİKEY)

PNT-03 FLANGE SPOT WELDING MACHINE 45kW (VERTICAL)



MAKİNANIN ÖZELLİKLERİ:

- Havalandırma kanallarına flanş ve tüm parçaları puntalanması için tasarlanmıştır.
 - Sağlam metal gövde
 - Yüksek transformatör gücü
 - Punta izlerini en makul seviyeye indirmeye imkan sağlayan; kaynak akımı, sıkma süresi, kaynak süresi, soğuma süresi ve tekrar süresi fonksiyonlarını hassas ayarlayabilen dijital göstergeli elektronik kontrol ünitesi
 - DKP, paslanmaz ve galvaniz sac ile yüksek performanslı punta yapabilme
 - Bakırdan üretilen punta kolları ve punta uçları ile kesintisiz kaynak kabiliyeti
 - Kızaklı punta kolları sayesinde esnek çalışma imkanı (Kollar 5cm hareket edebilir)
 - 45kW trafo • 380Vac 2Faz • 24vdc Valf • Pnömatik çalışır • Mikro işlemcili kumanda paneli
 - Su soğutmalı • 2mm+2mm Galvaniz sac • 3mm+3mm DKP sac • 3mm+3mm Paslanmaz sac
 - Kolay değiştirilebilir elektrot sistemi
- En: 500mm - Boy: 500mm - Yükseklik: 1600mm - Ağırlık: 400kg



MACHINE FEATURES

- Strong metal body
- High transformer power
- Electronic control unit with digital display that provides opportunity to reduce spot tracks to the most reasonable level and can accurately set welding current, squeeze time, welding time, cooling time and repeat time functions
- The possibility to make high performance spot with DKP, stainless and galvanized sheet
- Capability to make endless welding with spot handles and tailstocks made from copper
- Flexible working possibility thanks to sliding spot handles (handles can move for 5cm)
- 45kW transformer 380VAC 2phases 24vdc valve pneumatic operation with microprocessor control panel
- Water cooled 2mm + 2mm galvanized sheet 3mm + 3mm DKP sheet 3mm + 3mm stainless sheet
- Easily replaceable electrode system



Teknik Özellikleri

Technical Specifications

En/Width	:500mm
Boy/Length	:500mm
Yükseklik/Height	:1600mm
Ağırlık/Weight	:300kg
Elektrik/Electric	:220vac/50-60Hz/3faz

SF-01 SOĞUTUCU FAN SF-01 COOLING FAN



Teknik Özellikleri Technical Specifications

En/Width	:700mm
Boy/Length	:400mm
Yükseklik/Height	:500mm
Ağırlık/Weight	:35kg

SF-02 SOĞUTUCU FAN MİNİ CHILLER SF-02 COOLING FAN MİNİ CHILLER



Teknik Özellikleri Technical Specifications

En/Width	:700mm
Boy/Length	:400mm
Yükseklik/Height	:500mm
Ağırlık/Weight	:45kg

SF-03 SOĞUTUCU FAN MİNİ CHILLER BÜYÜK SF-03 COOLING FAN MİNİ CHILLER LARGE



Teknik Özellikleri Technical Specifications

En/Width	:600mm
Boy/Length	:530mm
Yükseklik/Height	:870mm
Ağırlık/Weight	:80kg

SLN-01 SİLİNDİR 127 MANUEL
SLN-01 CYLINDER SHEET BENDING MACHINE (127 MANUEL)



SLN-02 SİLİNDİR 127 TEZGAHLI MANUEL
SLN-02 CYLINDER SHEET BENDING MACHINE (127 MANUEL WITH WORKING BENCH)



SLN-03 SİLİNDİR 127 TEZGAHLI MOTORLU
SLN-03 CYLINDER SHEET MACHINE (127 MANUEL WITH ENGINE)



Teknik Özellikleri
Technical Specifications

	Kıvrma Uzunluğu Bending Length	Kıvrma Kapasitesi Bending Capacity	Merdane Çapı Roller Diameter	Dönme Hızı Rotation Speed	Motor Gücü Engine Power	Uzunluk Length	Genişlik Width	Yükseklik Height	Ağırlık Weight
SLN-01	1250mm	1mm	46mm		MANUEL	1620mm	500mm	400mm	150kg
SLN-02	1250mm	1,5mm	75mm		MANUEL	2150mm	700mm	1160mm	330kg
SLN-03	1250mm	1,5mm	75mm	8	1,5	2750mm	700mm	1160mm	330kg

KRD-01 KORDON MAKİNASI KÜÇÜK BOY
KRD-01 TRIMMING MACHINE (SMALL SIZE)



KRD-02 KORDON MAKİNASI ORTA BOY
KRD-02 TRIMMING MACHINE (MIDDLE SIZE)



KRD-03 KORDON MAKİNASI BÜYÜK BOY ELEKTRİKLİ
KRD-03 TRIMMING MACHINE (ELECTRICAL BIG SIZE)



Teknik Özellikleri
Technical Specifications

	Kıvrma Kapasitesi Bending Capacity	Top Çapı Top Diameter	Uzunluk Length	Genişlik Width	Yükseklik Height	Ağırlık Weight
KRD-01	1mm	52mm	380mm	180mm	380mm	30kg
KRD-02	1,2mm	62mm	560mm	220mm	500mm	50kg
KRD-03	1,2mm	62mm	900mm	450mm	1350mm	135kg

GYT-01 GİYOTİN MAKİNASI 130 GYT-01 GUILLOTINE SHEARS 130



Kapasitesi 1300x1,5mm olan makasımız mukavim platina sac gövdelidir. Böhler marka bıçakları ile size uzun yıllar hizmet edecektir. Arka dayaması çift kremayer millidir, böylece hassas kesim imkanı sağlar. Baskı kolu ile kesim sırasında sacın kayması en aza iner.



Our shears with capacity of 1300x1,5mm has resistant platinum sheet body. It will serve long years to you with its blades of Böhler brand. Its back gauges are double rack milled due to that it can provide accurate cutting possibility. Due to pressure handle the sliding of the sheet will be reduced to the maximum.



GYT-02 GİYOTİN MAKİNASI 105 GYT-02 GUILLOTINE SHEARS 105



Kapasitesi 105x1,5mm olan makasımız mukavim platin sac gövdelidir. Böhler marka bıçakları ile size uzun yıllar hizmet edecektir. Arka dayaması çift kremayer millidir, böylece hassas kesim imkanı sağlar. Baskı kolu ile kesim sırasında sacın kayması en aza iner.



Our shears with capacity of 105x1,5mm has resistant platinum sheet body. It will serve long years to you with its blades of Böhler brand. Its back gauges are double rack milled due to that it can provide accurate cutting possibility. Due to pressure handle the sliding of the sheet will be reduced to the maximum.



Teknik Özellikleri Technical Specifications

	Bıçak Boyu Blade Length	Kesme Boyu Cutting Length	Kesme Kapasitesi Cutting Capacity	En Width	Boy Length	Yükseklik Height	Ağırlık Weight
GYT-01	1270mm	1280mm	1,5mm	1040mm	2330mm	1600mm	370kg
GYT-02	1020mm	1050mm	1,5mm	1040mm	1920mm	1350mm	350kg



3 kW UPS



15 kW Servo Otomatik Voltaj Regulatorü
15 kW Servo Automatic Voltage Regulator



500 Lt. Komprasör
500 Lt. Compressor



Hava Kurutucu
Air Dryer



Oyma Makası
Graving Tool



El Makası Büyük Boy
Hand Shears Big Size

Türkiye'nin En Gelişmiş Havalandırma Kanal Makinaları

The Most Developed Ventilation Duct Machine In Turkey



KKM-01 KARE KANAL MAKİNASI
(HİDROLİK SİSTEM)
KKM-01 AUTO DUCT LINE
(HYDRAULIC SYSTEM)



PKM-01 PANÇLI KARE KANAL MAKİNASI
PKM-01 AUTO DUCT FORMER WITH
NOTCHING SYSTEM



KKM-02 KANAL KAPATMA MAKİNASI
KKM-02 SEAM CLOSER



PLZ-01 PLAZMA KESİM MAKİNASI
PLZ-01 PLASMA CUTTER



PSB-01 PLAZMA SAC BESLEME
MAKİNASI
PSB-01 PLASMA SHEET FEEDING
MACHINE



BKEM-01 BORU KENET EZME MAKİNASI
BKEM-01 PIPE LOCK SEAMER



FKM-01 FLANŞ KESME MAKİNASI
FKM-01 FLANCE CUTTING MACHINE



KDK-01 KARE DİRSEK KAPATMA
MAKİNASI
KDK-01 PITTSBURGH SEAM CLOSER



KNT-01 KENET MAKİNASI (DİRSEKLI)
KNT-01 LOCK FORMER (WITH ELBOW)



CPM-01 C PROFİL MAKİNASI
CPM-01 C PROFILE MAKING MACHINE



FM-01 TDF KENDİNDEN FLANŞLI MAKİNA
FM-01 SELF FLANGED MACHINE



KYM-01 KAREDEN YUVARLAK MAKİNASI
KYM-01 RECTANGULAR TO ROUND
MACHINE



BKM-01 BOY KESME MAKİNASI
BKM-01 LENGTH CUTTING MACHINE



İZ-01 İZ MAKİNASI 130
İZ-01 Z PROFILE MACHINE 130



SNT-01 SANTİM MAKİNASI
SNT-01 FLANGİNG MACHINE



GYT-01 GIYOTİN MAKİNASI 130
GYT-01 GUILLOTINE SHEARS 130





3E MAKİNA
SAN. VE TİC. LTD. ŞTİ.

Muratpaşa Mah. Fabrikalar Cad. No:5/7C
Bayrampaşa - İstanbul
Tel: +90 212 736 11 29

